

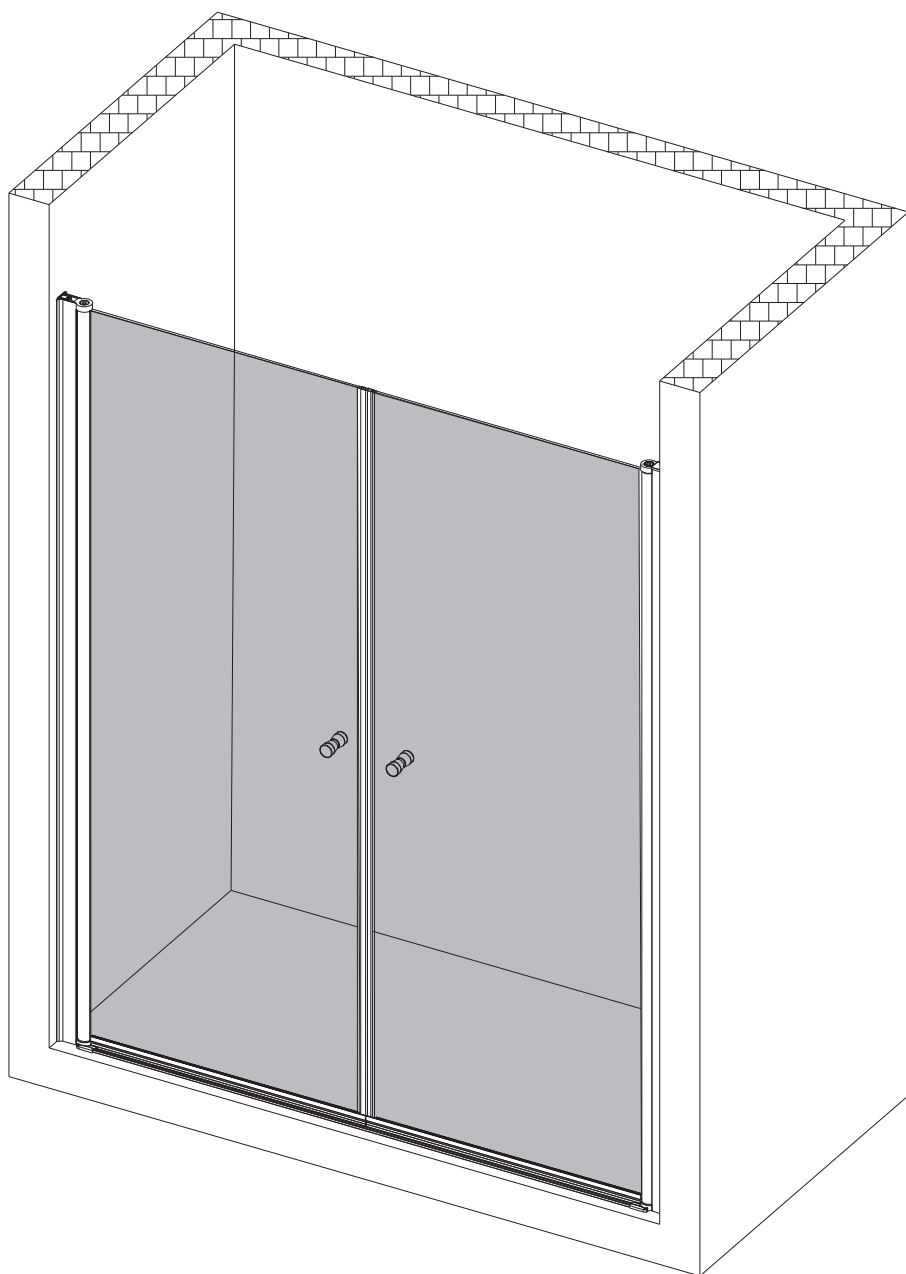

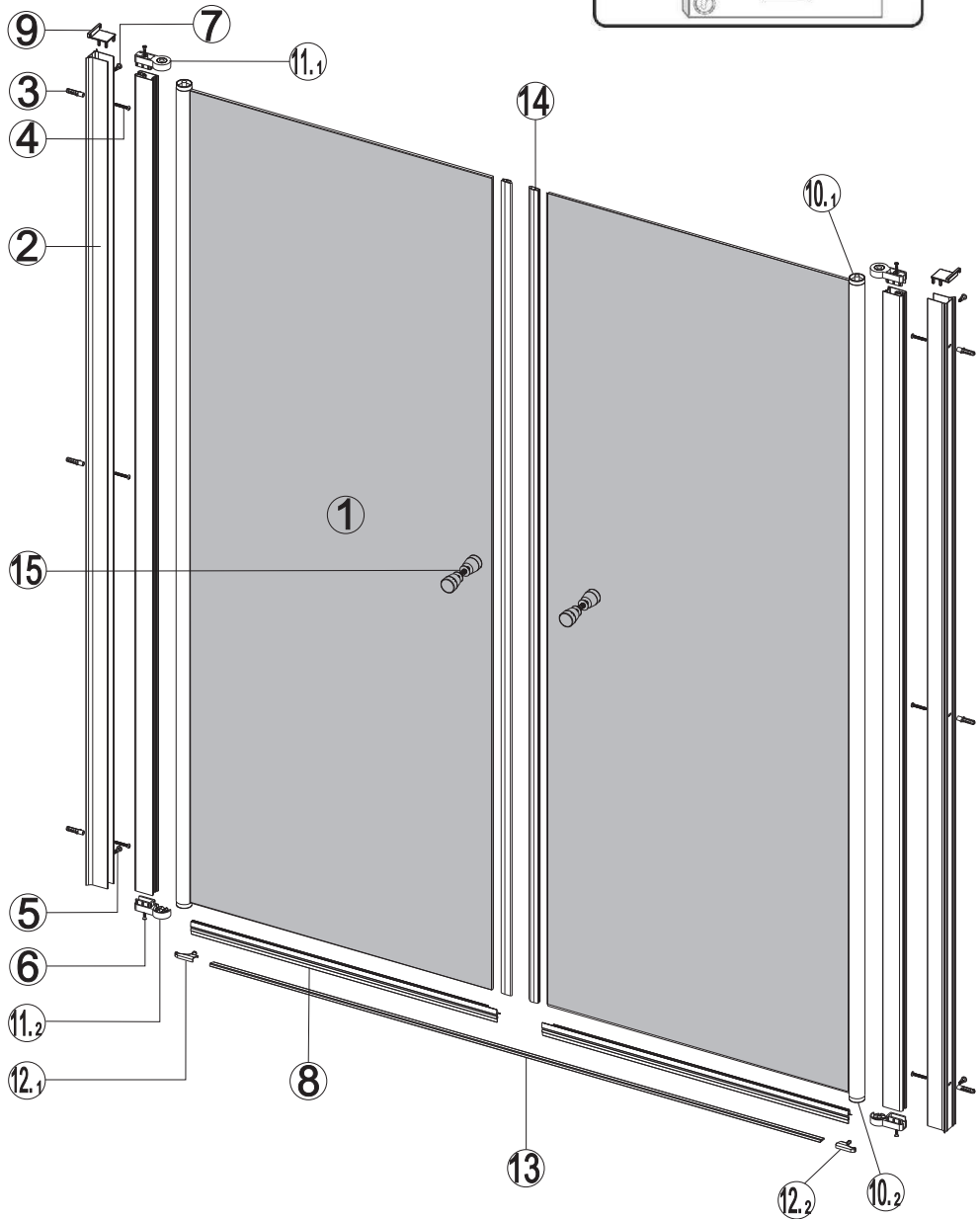

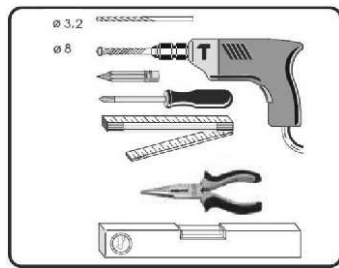

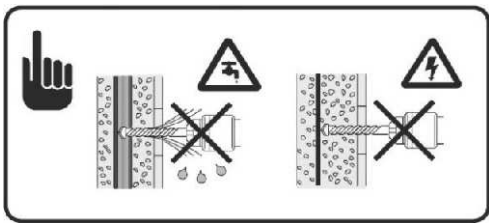

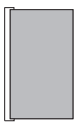

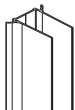



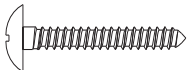

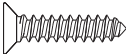

## Dvojkřídlové sprchové dveře do niky Sanovo T2



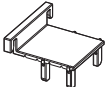
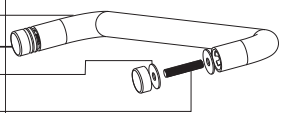
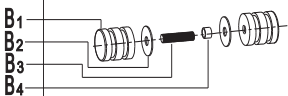
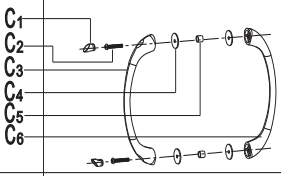

NO.	Designation	Pieces	NO.	Designation	Pieces
1		X2	10 <sub>1</sub>		X2
2		X2	10 <sub>2</sub>		X2
3	 $\varnothing 8$	X6+1	11 <sub>1</sub>		X2
4	 $\varnothing 4$ ST4X35	X6+1	11 <sub>2</sub>		X2
5	 $\varnothing 4$ ST4X10	X4+1	12 <sub>1</sub>		X1
6	 $\varnothing 4$ ST4X30	X4+1	12 <sub>2</sub>		X1
7		X4+1	13		X1
8		X2	14		X2
9		X2	A <sub>1</sub>		X2
		A <sub>2</sub>	X4		
		A <sub>3</sub>	X8		
		A <sub>4</sub>	X4		
		B <sub>1</sub>		X4	
		B <sub>2</sub>		X4	
		B <sub>3</sub>		X2	
		B <sub>4</sub>		X2	
		C <sub>1</sub>		X4	
		C <sub>2</sub>		X4	
		C <sub>3</sub>		X2	
		C <sub>4</sub>		X8	
		C <sub>5</sub>		X4	
		C <sub>6</sub>		X2	
		D	<b>No handle</b>		
			 $\varnothing 8$  $\varnothing 3.2$		

1.

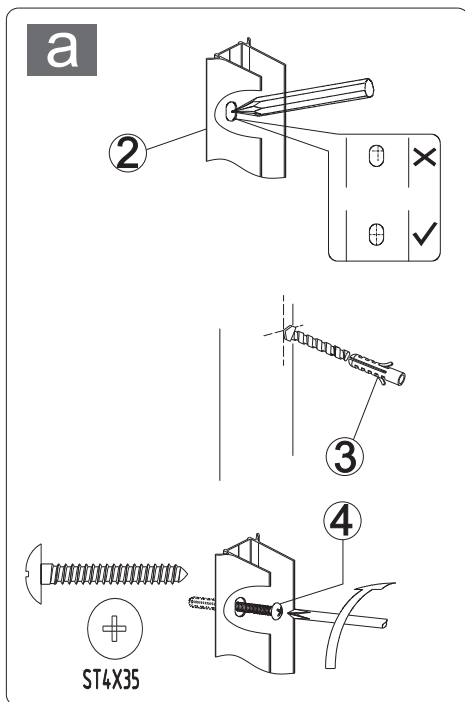
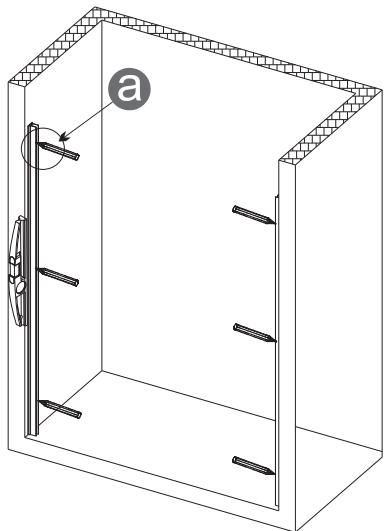

2.

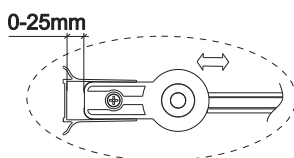
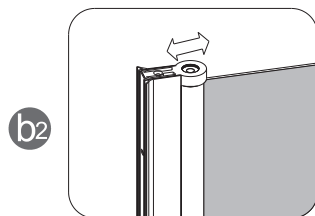
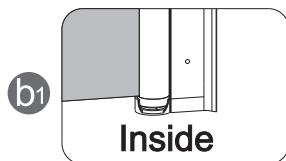
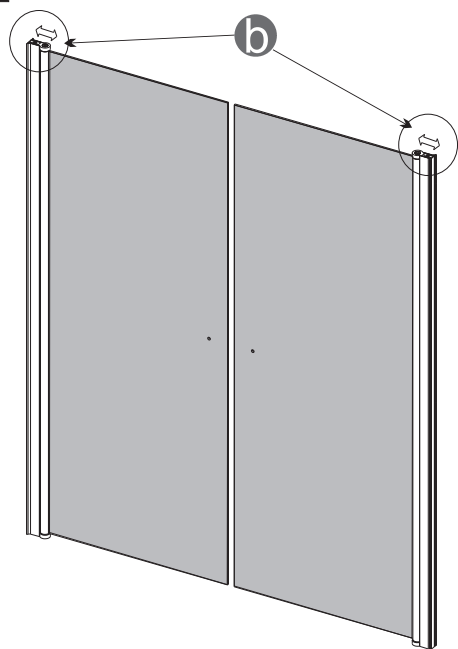

3.

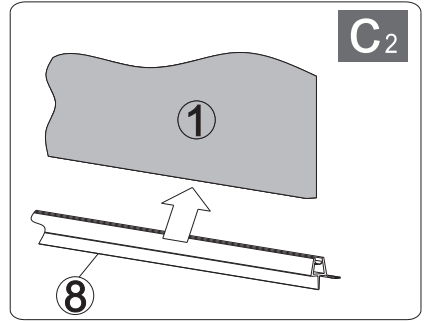
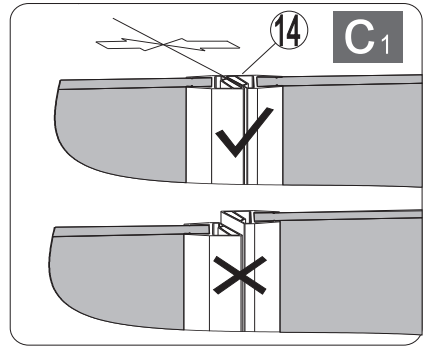
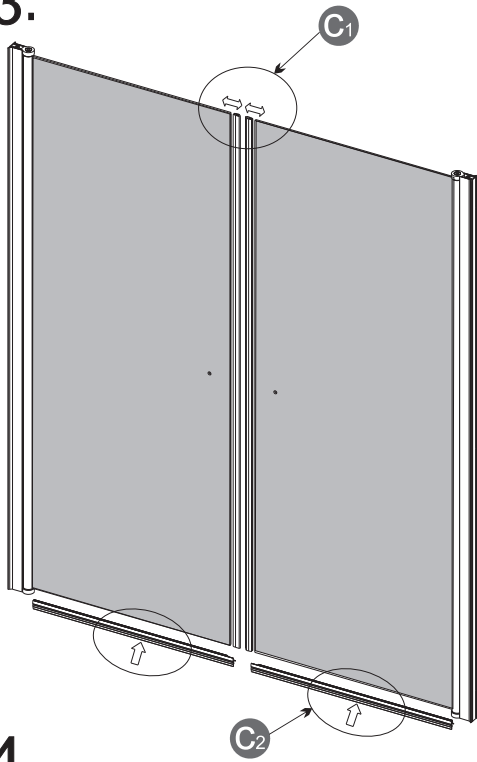

4.

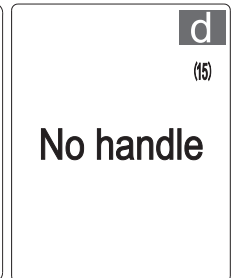
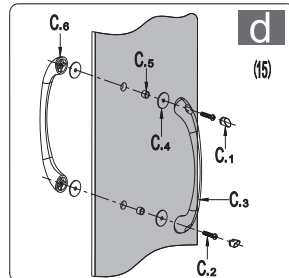
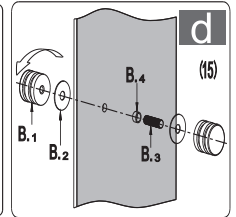
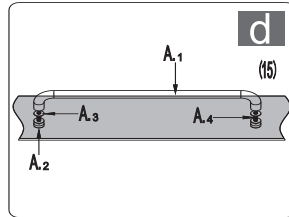
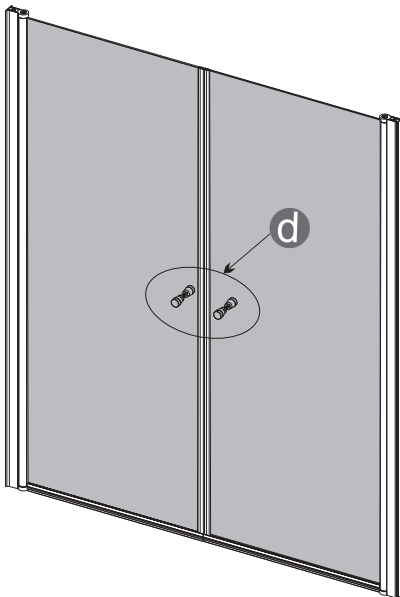

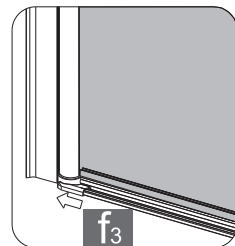
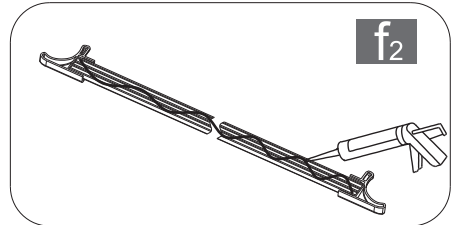
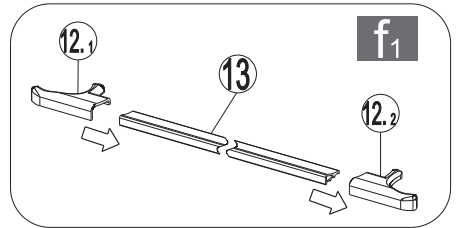
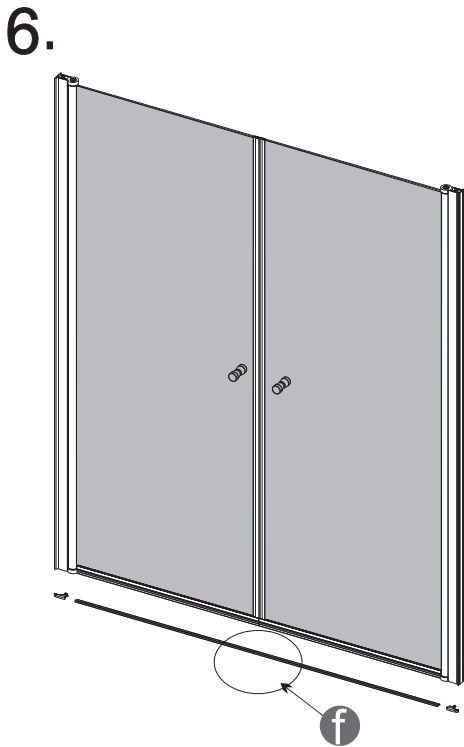
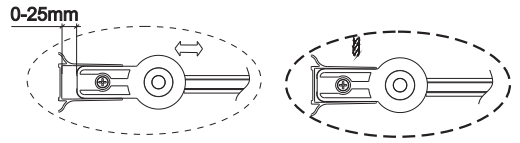
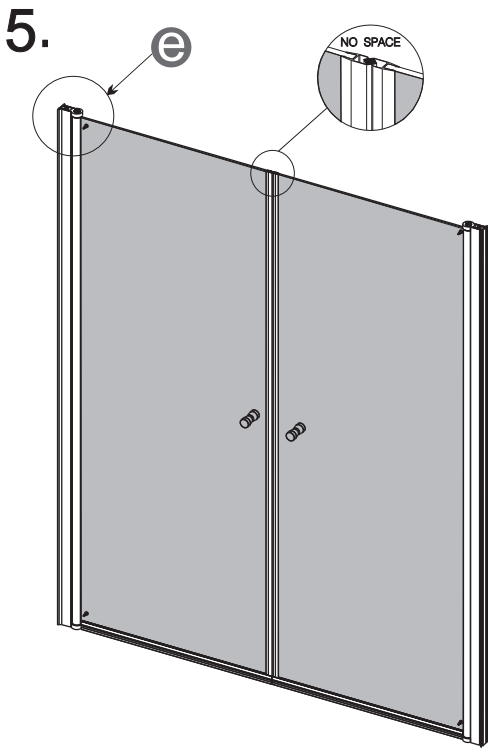

7.

